

Current part is item (17) on diagram. Available at www.oshkoshequipment.com

(1) (a) FIG. NO.	(2) (b) ITEM NO.	(3) SMR CODE	(4) NATIONAL STOCK NUMBER	(5) PART NUMBER	(6) DESCRIPTION	(7) U/M	(8) INC IN UNIT
GROUP 18-BODY,CAB,HOOD,AND HULL							
1801-BODY,CAB,HOOD,AND HULL ASSEMBLIES							
152	3	PAOZZ	5340-00-753-9201	7539201	19207 BUMPER,RUBBER: HOOD SIDE PANEL	EA	3
152	4	PAOZZ	5305-00-057-9612	MS24621-30	96906 SCREW,TAPPING	EA	1
152	5	PAOZZ	5340-00-753-9220	7539220	19207 BUMPER,RUBBER: SIDE PANEL	EA	1
153	1	PAOZZ	5340-00-753-9201	7539201	19207 BUMPER,RUBBER: HOOD SIDE PANEL	EA	1
153	11	PAOZZ	5305-00-057-9612	MS24621-30	96906 SCREW,TAPPING	EA	1
153	12	PAOZZ	5340-00-753-9220	7539220	19207 BUMPER,RUBBER: SIDE PANEL	EA	1
154	1	PAOZZ	5310-00-959-7600	MS51922-5	96906 NUT,SELF-LOCKING	EA	2
154	2	PAOZZ	5305-00-068-0504	MS90726-3	96906 SCREW,CAP,HEXAGON H D	EA	2
154	3	XBOZZ		7397931	19207 REINFORCEMENT	EA	2
154	4	PAOZZ	2540-00-753-9214	7539214	19207 FASTENER,CYLINDER SPRING: HOOD TOP PANEL TO WINDSHIELD	EA	2
154	5	PAOZZ	5305-00-068-0505	MS90726-5	96906 SCREW,CAP,HEXAGON H D	EA	4
154	6	PAOZZ	2510-00-753-9213	7539213	19207 BRACKET: HOOD TOP PANEL TO WINDSHIELD CATCH	EA	2
154	7	PAOZZ	2540-00-622-7754	7397928	19207 REINFORCEMENT HINGE	EA	2
154	8	PAOZZ	5305-00-068-0506	MS90726-6	96906 SCREW,CAP,HEXAGON H D	EA	8
154	9	PAOZZ	5340-00-753-9193	7539193	19207 HINGE,STRAP	EA	2
154	10	PAOZZ	5305-00-989-7434	MS35207-263	96906 SCREW,MACHINE	EA	4
154	11	PAOZZ	5310-00-877-5797	MS21044N3	96906 NUT,SELF-LOCKING	EA	4
154	12	PAOZZ	5340-00-278-0213	7539218	19207 BRACKET,DOOR CATCH: FRONT	EA	2
154	13	PAOZZ	5320-00-013-6326	MS35684-21	96906 RIVET,SPLIT: HOOD WINDSHIELD BUMPER	EA	8
154	14	PAOZZ	5330-00-321-6397	8330495	19207 BUMPER,RUBBER: HOOD TOP PANEL	EA	2
154	15	PAOZZ	2510-00-737-2770	7372770	19207 CATCH ASSEMBLY,HOOD	EA	1
154		PAOZZ	7690-00-165-6608	11647909	19207 DECAL,WARNING HOOD	EA	1
154	16	PAOZZ	5310-00-877-5796	MS21044N4	96906 NUT,SELF-LOCKING		
154	17	PAOZZ	2590-00-040-2075	7539197	19207 FASTENER,CYLINDER SPRING: HOLD-DOWN TOP PANEL	EA	2
154	19	PAOZZ	2510-00-737-2767	7372767	19207 HOOK: HOOD TO PANEL, WITH EYE BOLT	EA	1
154	20	PAOZZ	5310-00-984-3807	MS51922-13	96906 NUT,SELF-LOCKING	EA	2
154	21	PAOZZ	5310-00-264-4085	7372766	19007 WASHER,SPRING,TENSION	EA	1
154	22	PAOZZ	5306-00-737-2765	7372765	19207 BOLT,EYE	EA	1

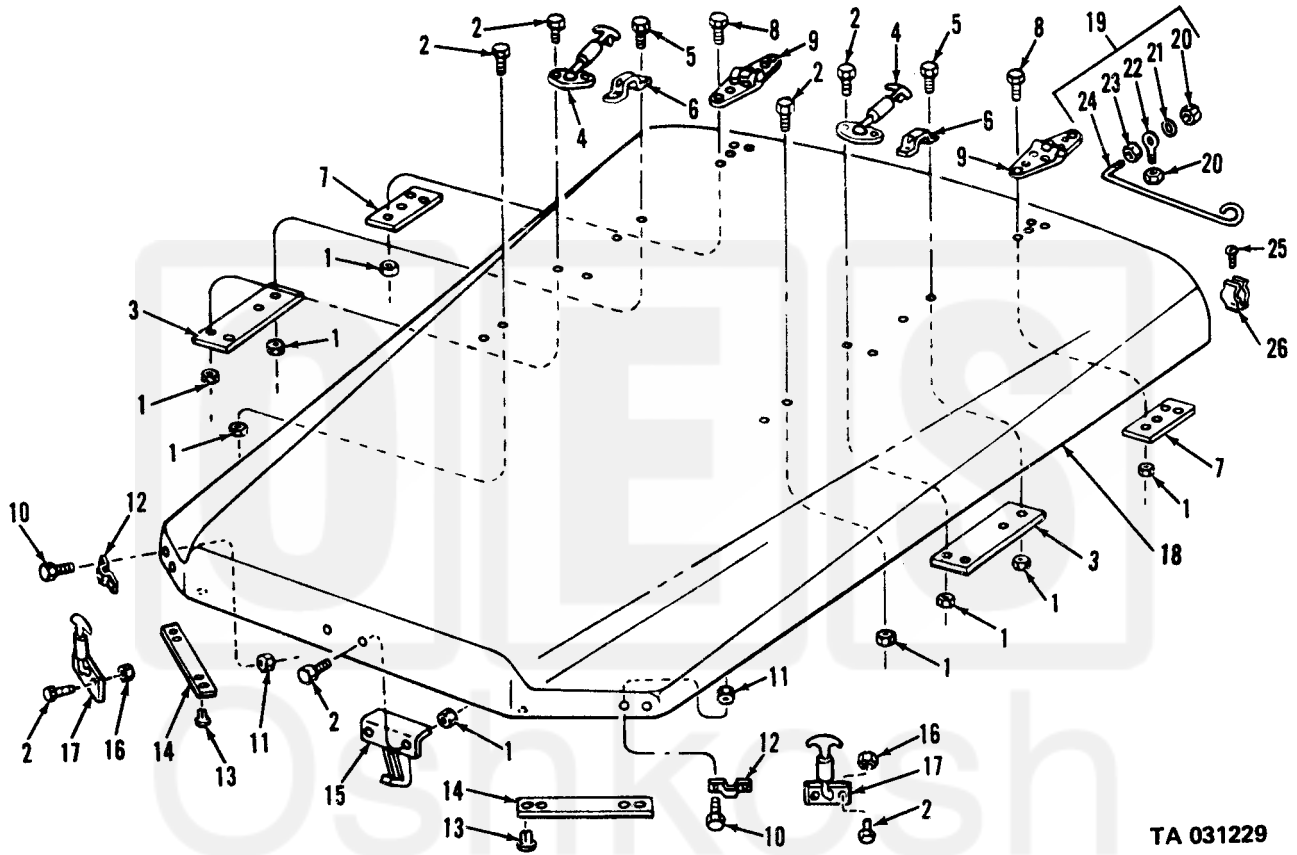

Current part is item (17) on diagram. Available at www.oshkoshequipment.com



TA 031229

Figure 154. Hood assembly.